



FIBERGLASS DOOR UNIT
6'-8" DOUBLE DOOR WITH / WITHOUT SIDELITES

GENERAL NOTES

- EVALUATED FOR USE IN LOCATIONS ADHERING TO THE FLORIDA BUILDING CODE AND WHERE PRESSURE REQUIREMENTS AS DETERMINED BY ASCE 7, MINIMUM DESIGN LOADS FOR BUILDINGS AND OTHER STRUCTURES, DOES NOT EXCEED THE DESIGN PRESSURES LISTED.
- WHEN INSTALLED IN THE HIGH VELOCITY HURRICANE ZONE (HVHZ), HURRICANE PROTECTIVE SYSTEM (SHUTTERS) IS REQUIRED.
- WHEN INSTALLED IN THE WIND-BORNE DEBRIS REGION, HURRICANE PROTECTIVE SYSTEM (SHUTTERS) IS REQUIRED.
- POLYURETHANE CORE FLAME SPREAD INDEX OF 50 AND SMOKE DEVELOPED INDEX OF 60 PER ASTM E84.
- PLASTICS TESTING:

TEST DESCRIPTION	DESIGNATION	FACING	LITE FRAME
SELF IGNITION TEMP	ASTM D1929	752 °F > 650 °F	842 °F > 650 °F
RATE OF BURNING	ASTM D635	0.56 IN/MIN	1.28 IN/MIN
SMOKE DENSITY	ASTM D2843	53.4%	70.2%
TENSILE STRENGTH*	ASTM D638	3.2% DIFF	1.8% DIFF

- PLASTICS TESTING OF WORLDWIDE COMPOSITE FRAME (WHERE USED):

TEST DESCRIPTION	DESIGNATION	RESULT
SELF IGNITION TEMP	ASTM D1929	779 °F > 650 °F
RATE OF BURNING	ASTM D635	0.0 IN/MIN
SMOKE DENSITY	ASTM D2843	39.0%
TENSILE STRENGTH*	ASTM D638	3.6% DIFF

* COMPARATIVE TENSILE STRENGTH AFTER WEATHERING 4500 HOURS XENON ARC METHOD 1

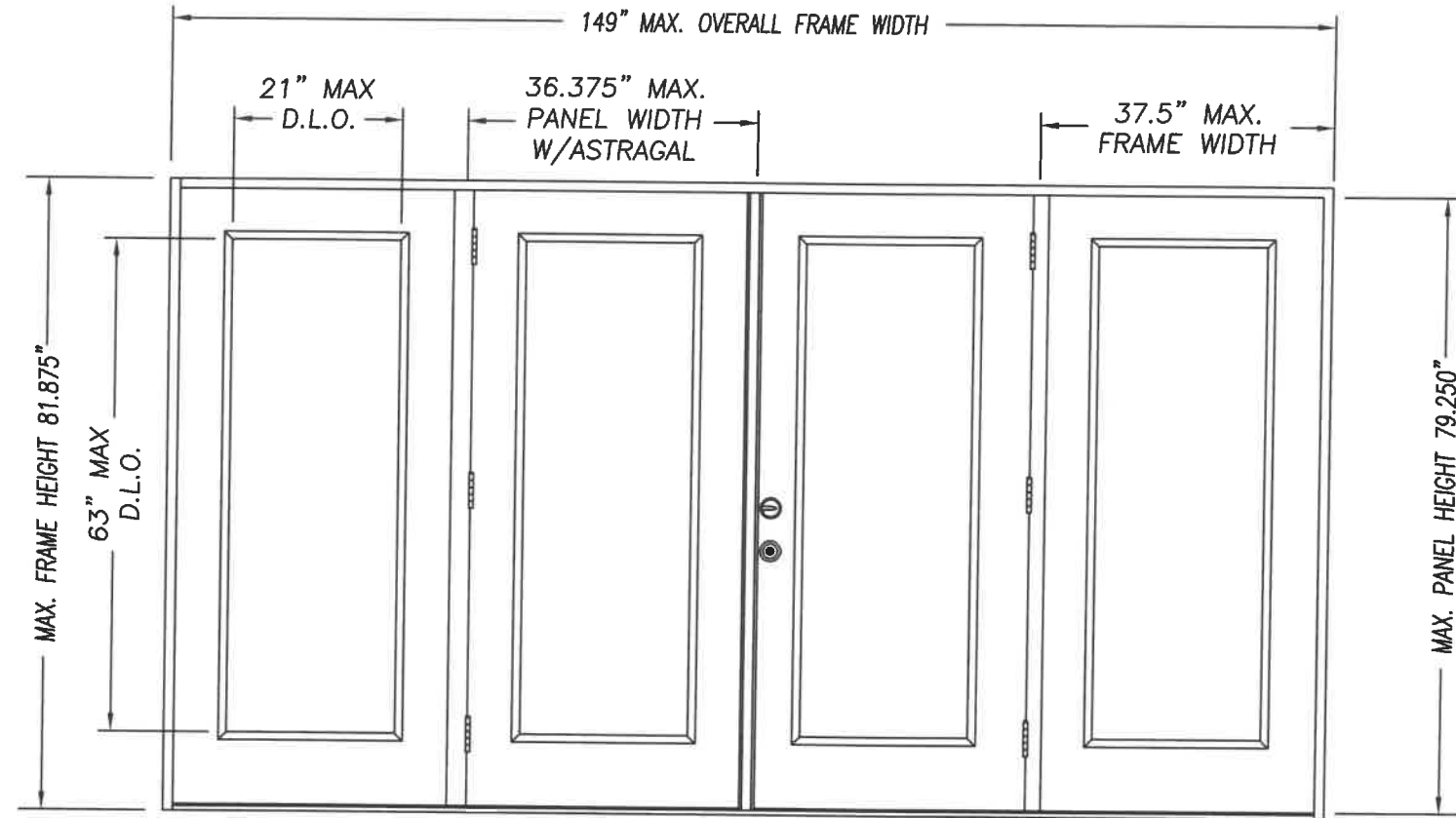

DOUBLE DOOR UNIT W/SIDELITES

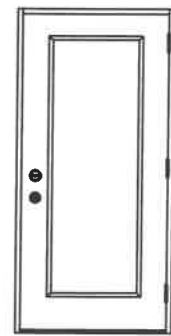

SINGLE DOOR UNIT

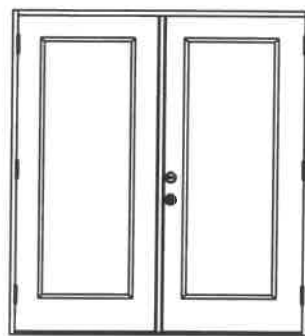

DOUBLE DOOR UNIT

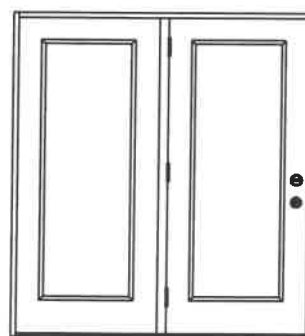

SINGLE DOOR UNIT WITH SIDELITE

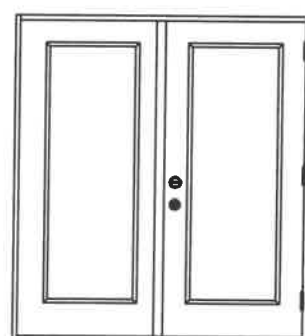

SINGLE DOOR UNIT WITH SIDELITE

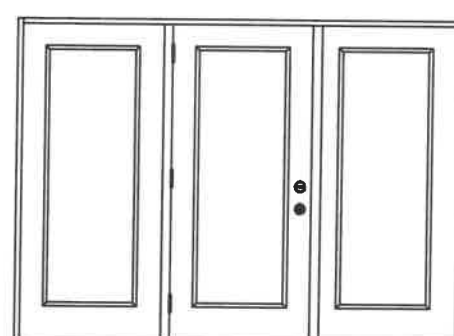

SINGLE DOOR UNIT W/SIDELITES

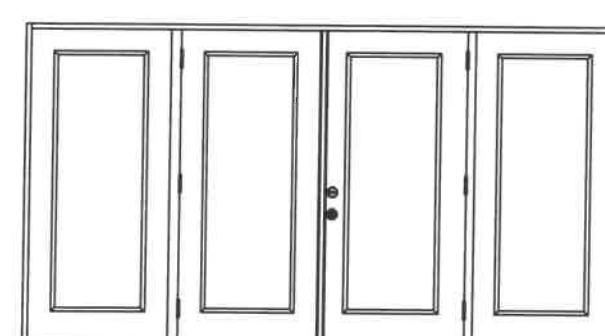

DOUBLE DOOR UNIT W/SIDELITES

Addendum to NAMI

Certification No.: NI013217
Reviewed By: [Signature]
Date Reviewed: 11/28/17

CONFIG	MAX WIDTH	DESIGN PRESSURE RATING		WHERE WATER INFILTRATION PERFORMANCE IS REQUIRED TO BE 15% OF DESIGN PRESSURE				
		INSWING	OUTSWING	INSWING	BUMPER O/S	Z-SERIES O/S	T4 O/S	HIGH DAM O/S
X	37.5"	+40.0 / -40.0	+40.0 / -40.0	N/A	+25.0 / -25.0	+40.0 / -40.0	+40.0 / -40.0	+40.0 / -40.0
XX	74"	+40.0 / -40.0	+40.0 / -40.0	N/A	+25.0 / -25.0	+40.0 / -40.0	+40.0 / -40.0	+40.0 / -40.0
OX or XO	75"	+40.0 / -40.0	+40.0 / -40.0	N/A	+25.0 / -25.0	+40.0 / -40.0	+40.0 / -40.0	+40.0 / -40.0
OXO	112.5"	+40.0 / -40.0	+40.0 / -40.0	N/A	+25.0 / -25.0	+40.0 / -40.0	+40.0 / -40.0	+40.0 / -40.0
OXXO	149"	+40.0 / -40.0	+40.0 / -40.0	N/A	+25.0 / -25.0	+40.0 / -40.0	+40.0 / -40.0	+40.0 / -40.0

TABLE OF CONTENTS

SHEET #	DESCRIPTION
1	TYPICAL ELEVATIONS & GENERAL NOTES
2	ANCHORING LOCATIONS & DETAILS
3	ANCHORING LOCATIONS & DETAILS

Kurt Balthazor

KURT BALTHAZOR
FLORIDA P.E.
#56533

MASONITE INTERNATIONAL CORP.
1955 POWIS ROAD
WEST CHICAGO, IL 60185

PRODUCT: "EXTERIOR DOOR PRODUCT"
DOUBLE 6'8" GLAZED
FIBERGLASS DOOR
PART OR ASSEMBLY:
TYPICAL ELEVATIONS
& GENERAL NOTES

NO.	DATE	UPDATED DATA	SWS	BY
A	11/27/17			

DATE: 4/26/17
SCALE: N.T.S.
DWG. BY: SWS
CHK. BY:
DRAWING NO.:
DWG-MA-FL0189-17
SHEET 1 OF 3

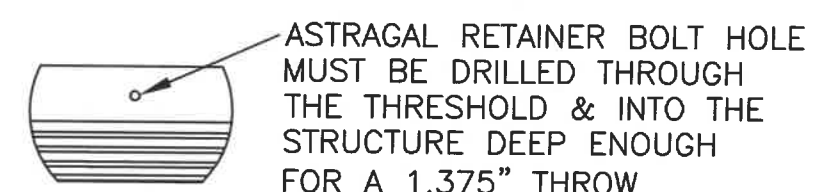
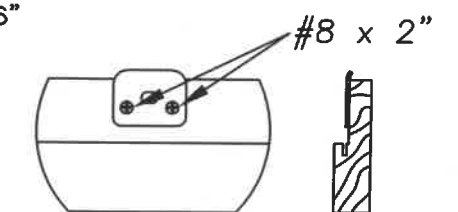
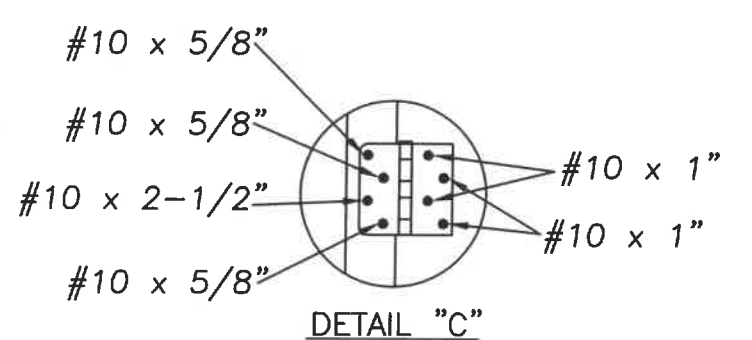
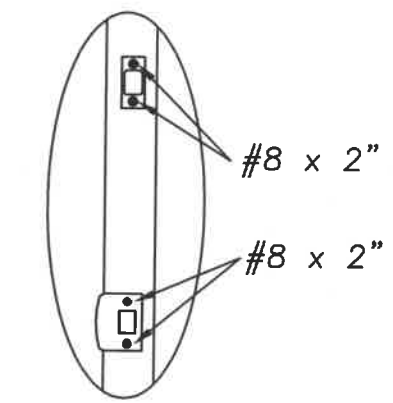
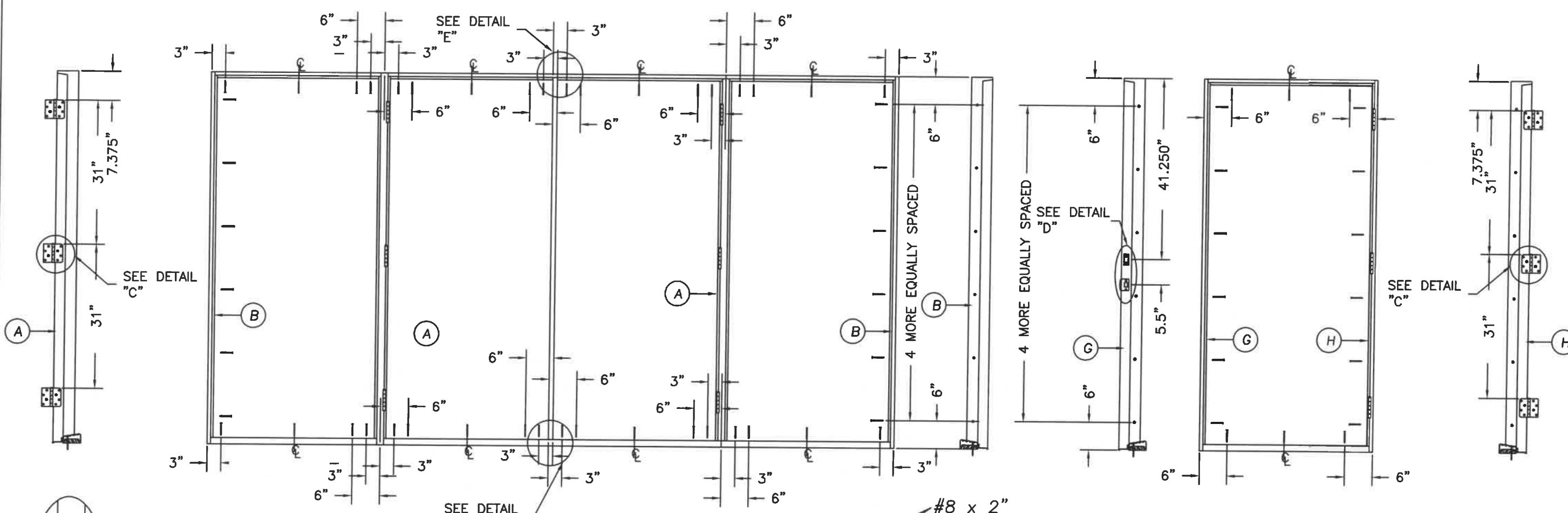

DETAIL "E" ASTRAGAL
 ATTACH ASTRAGAL RETAINER BOLT STRIKE PLATE TO FRAME AS SHOWN.

DETAIL "F" ASTRAGAL
 ASTRAGAL RETAINER BOLT HOLE MUST BE DRILLED THROUGH THE THRESHOLD & INTO THE STRUCTURE DEEP ENOUGH FOR A 1.375" THROW

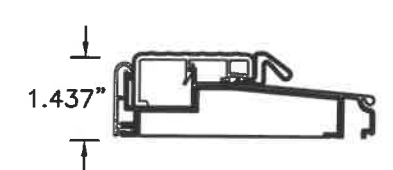
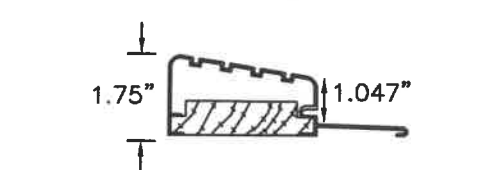
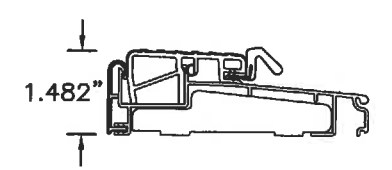
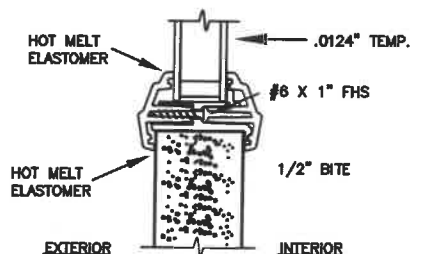
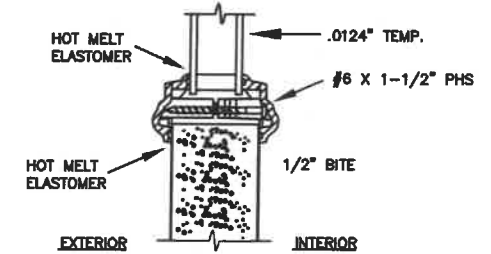
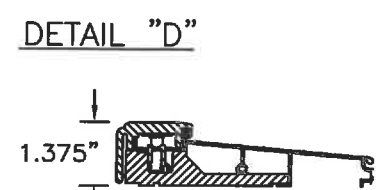

Z-SERIES O/S THRESHOLD HIGH DAM O/S THRESHOLD T4 O/S THRESHOLD

Addendum to NAMI
 Certification No.: NI013717
 Reviewed By: *[Signature]*
 Date Reviewed: 11/28/17

PRODUCT:	EXTERIOR DOOR PRODUCT 6'-8" FIBERGLASS GLAZED DOUBLE DOOR UNIT	
PART OR ASSEMBLY:	ANCHORING LOCATIONS & DETAILS	
NO.	11/27/17	DATE
UPDATED DATA	SWS	BY
REVISIONS		
DATE:	4/26/17	
SCALE:	N.T.S.	
DWG. BY:	SWS	
CHK. BY:		
DRAWING NO.:	DWG-MA-FL0189-17	
SHEET	2 OF 3	

MASONITE INTERNATIONAL CORP.
 1955 POWIS ROAD
 WEST CHICAGO, IL 60185

PRODUCT: "EXTERIOR DOOR PRODUCT"
 6'-8" FIBERGLASS GLAZED
 DOUBLE DOOR UNIT
 PART OR ASSEMBLY:
 ANCHORING LOCATIONS
 & DETAILS

NO.	DATE	UPDATED DATA	SWS	BY
A	11/27/17			

DATE: 4/26/17
 SCALE: N.T.S.
 DWG. BY: SWS
 CHK. BY:
 DRAWING NO.:
 DWG-MA-FL0189-17
 SHEET 3 OF 3

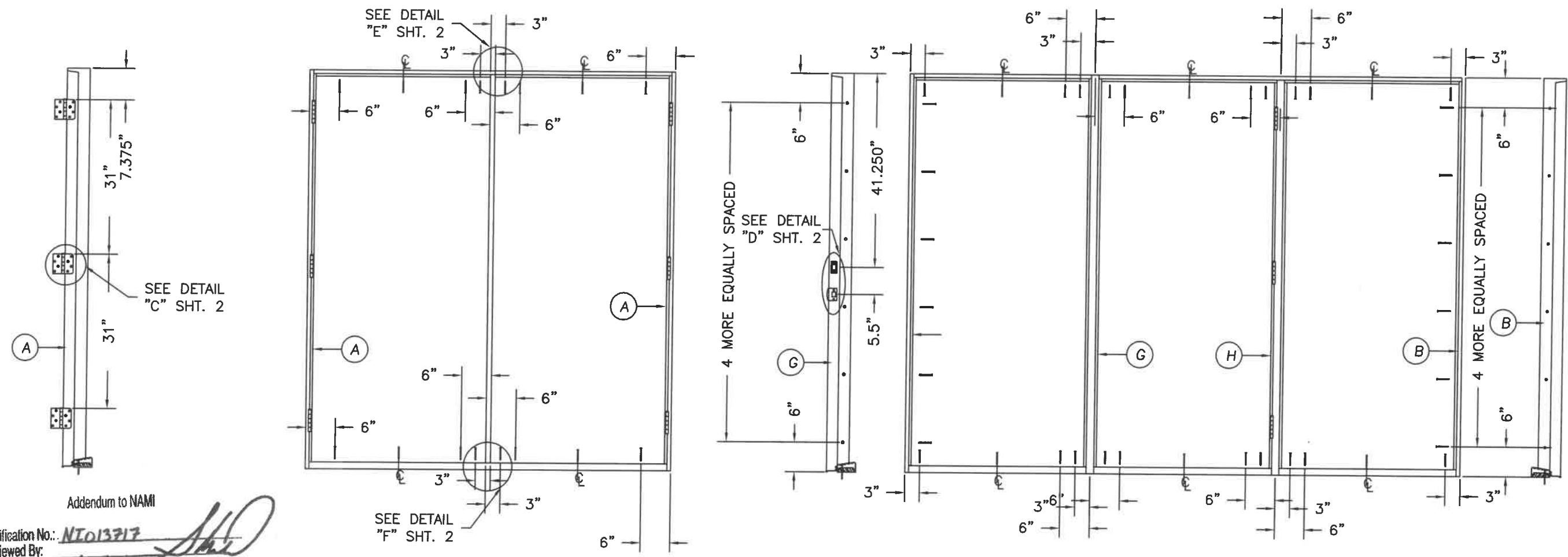

Addendum to NAMI
 Certification No.: NT013717
 Reviewed By: *[Signature]*
 Date Reviewed: 11/28/17

ATTACHMENT DETAIL

- ANCHOR ANALYSIS FOR LOADING CONDITIONS PREPARED, SIGNED AND SEALED BY ROBERTO LOMAS, PE (FLORIDA #62514) WITH THE LOWEST (LEAST) FASTENER RATING FROM THE DIFFERENT FASTENERS BEING CONSIDERED FOR USE. JAMB, HEAD, AND THRESHOLD FASTENERS ANALYZED FOR THIS UNIT INCLUDE #10 WOOD SCREWS, 1/4" TAPCONS, AND #10 TEK SCREWS. A PHYSICAL SHIM MUST BE PLACED IN SHIM SPACE AT EACH ANCHOR LOCATION. TAPCON EDGE DISTANCE MIN 2-1/2". WOOD SCREW EDGE DISTANCE MIN 3/4". TEK SCREW EDGE DISTANCE MIN 1/2".
- ANCHORING INTO STEEL STRUCTURE MUST BE SUFFICIENT TO ACHIEVE 3 THREADS MINIMUM BEYOND STEEL INTERIOR SURFACE.
- THE WOOD SCREW SINGLE SHEAR DESIGN VALUES COME FROM ANSI/AF&PA NDA FOR SOUTHERN PINE LUMBER AND ACHIEVEMENT OF 1-1/2" MINIMUM EMBEDMENT. THE TAPCON MUST ACHIEVE MINIMUM EMBEDMENT OF 1-1/4".
- WOOD BUCKS BY OTHERS MUST BE ANCHORED PROPERLY TO TRANSFER LOADS TO STRUCTURE.
- MINIMUM DESIGN VALUE STRENGTH OF ANCHORS 155 LBS.

HARDWARE SCHEDULE

- KWIKSET SERIES 400 GRADE 3 CYLINDRICAL LATCH AND SERIES 980 GRADE 1 DEADLOCK HARDWARE TO BE INSTALLED AT 5-1/2" CENTERLINE.
- 4" X 4" FULL MORTISE BUTT HINGES.

