

# Aluminum Soffit & Fascia System Installation Guide



**ALSCO**<sup>®</sup>

Thank you for choosing ALSCO® aluminum soffit for your project. These instructions describe and illustrate the steps involved in installing aluminum soffit and fascia. ALSCO shall not accept any liability or responsibility under its written warranty for failure caused by improper installation.

## Creating A Balanced System

A proper attic ventilation system allows a continual flow of outside air through your attic and consists of a balance between air intake (at your eaves or soffits) and air exhaust. Optimal ventilation can be strategically controlled by alternating solid and vented soffit panels coupled with exhaust products.

To determine the correct amount of ventilation, you will need to calculate the required Net Free Air or NFA. This is the open area for air to pass through vented products.

Please refer to local building codes to determine proper ventilation requirements.

## TABLE OF CONTENTS

PROJECT PLANNING . . . . .	3
SOFFIT & FASCIA INSTALLATION. . . . .	4-5
SOFFIT COMPONENTS. . . . .	6-7
SOFFIT CALCULATION CHARTS/REFERENCE. . . . .	8-9
SOFFIT SUPPORT RECOMMENDATION. . . . .	10

## PLANNING

To determine the amount of material to order, follow these simple steps.

### 1. STARTER

Measure total length of walls to which soffit panels attach. Determine type of starter to use.

- **F Channel** for new construction
- **J Channel** for remodeling

### 2. SOFFIT PANELS

Measure overhang from building wall to outside of fascia board. Determine number of square feet of panel needed by multiplying width of overhang by total length of fascia board.

**Example:**

2' overhang x 200' of fascia board = 400 square feet of panel required.

### 3. FASCIA COVER

Measure total length of fascia board to be covered. Measure height of fascia board.

- Order: **BASL4** to cover 4" fascia board.  
**BASL6** to cover 6" fascia board.  
**BASL8** to cover 8" fascia board.  
**BASL10** to cover 10" fascia board.

### 4. DOUBLE CHANNEL RUNNER

For each corner, measure from outside corner of building wall to inside corner of fascia board.

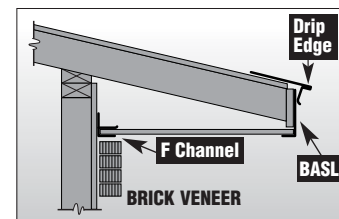
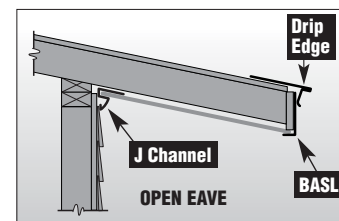
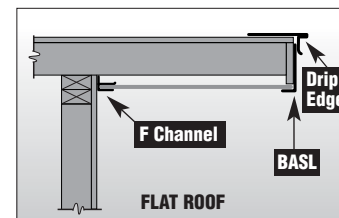
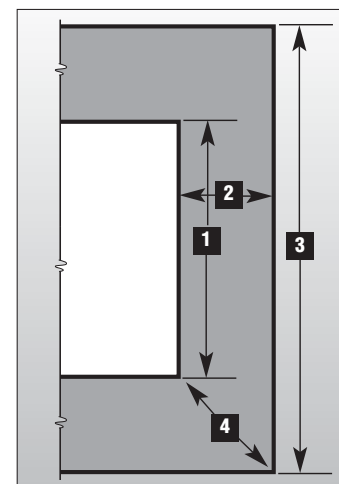

## INSTALLING SOFFIT

### 1. STARTER

New Construction – snap chalk line to side of house level with bottom of fascia board. Nail F Channel so that bottom is 3/8" below chalk line.

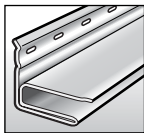

F Channel



### 2. STARTER

Remodeling – remove old trim and nail J Channel to existing soffit.

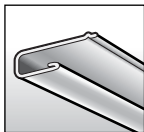

J Channel

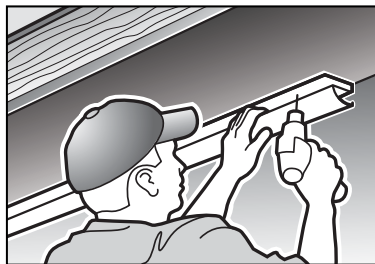

### 3. SOFFIT PANELS

Cut to length with a circular saw or a hack saw. Then insert into starter and nail to bottom of fascia board. Nail through the flange or the grooves only. Insert tongue of next panel into flange of installed panel and continue for length of run.



### 4. CORNERS

Trim Double Channel Runner to make a point at one end and a "V" at the other end. The point end fits against the fascia boards and the "V" end fits against the corner of the house. Nail into place.

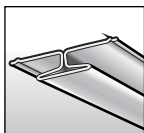

Double Channel Runner

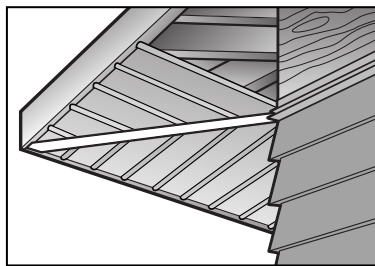

### 5. FASCIA COVER

Drill nailing holes in fascia cover slightly larger than the nail being used. Nail through the drilled holes. Let fascia cover "hang". Do not drive nails home.



BASL Fascia



## FASCIA CORNERS

When overlapping fascia panels, first cut a notch in the underlying panel. The notch should be 1-1/2" long. Slip the notched panel into the adjacent panel.

For outside corners: Bend a 1" flange on the first fascia piece, 90 degrees around the corner. Cut overlapping fascia at 45 degree angle. Nail with painted steel or aluminum trim nails. Use the same technique for inside Corner Fascia but bend in the opposite direction to form an inside corner shape.

Face nailing can result in a wavy or buckled appearance during thermal expansion and contraction cycles. Always use a drip edge, gutter, or trim to receive cut top edge of fascia to provide clean appearance and protect the substrate material from moisture.

## CHECK LIST FOR ESTIMATING YOUR NEEDS

### PANELS

12" \_\_\_\_\_ SQ. FT.

16" \_\_\_\_\_ SQ. FT.

### STARTERS

J Channel \_\_\_\_\_ LINEAL FT.

F Channel \_\_\_\_\_ LINEAL FT.

### FASCIA COVER

BASL4 \_\_\_\_\_ LINEAL FT.

BASL6 \_\_\_\_\_ LINEAL FT.

BASL8 \_\_\_\_\_ LINEAL FT.

BASL10 \_\_\_\_\_ LINEAL FT.

### ACCESSORIES

Double Channel Runner \_\_\_\_\_ LINEAL FT.

Drip Edge \_\_\_\_\_ LINEAL FT.

## SOFFIT COMPONENTS

Here are descriptions and dimensions of the components you may need.  
 Page 5 features a convenient check list to fill out and take to your ALSCO Dealer.

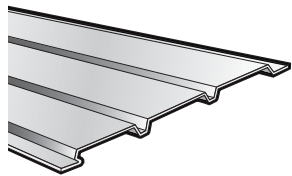

### 12" PANEL

SOLID

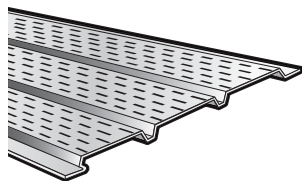

FULLY VENTED

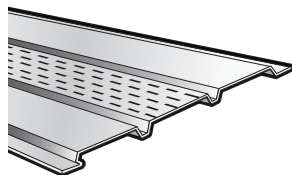

CENTER VENT

### 16" PANEL

SOLID

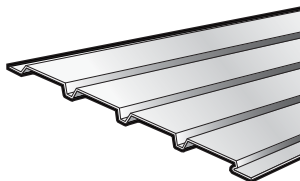

FULLY VENTED

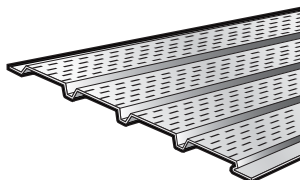

CENTER VENT

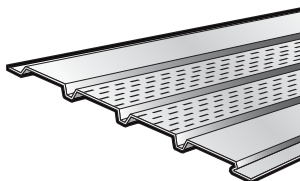

## SOFFIT COMPONENTS

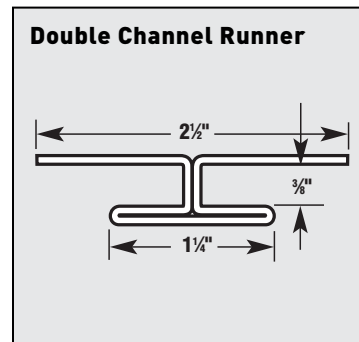
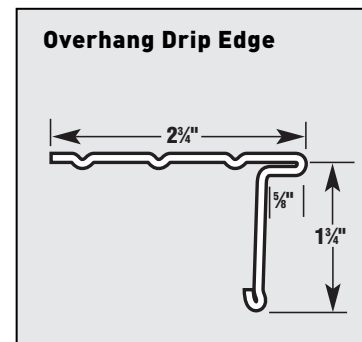
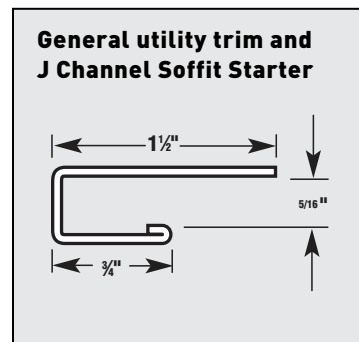
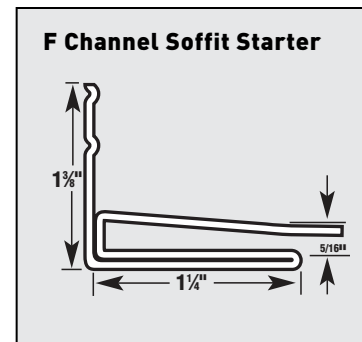
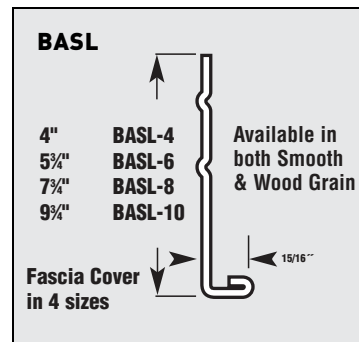

## Aluminum Soffit System Calculation Chart — 16"

To determine the number of 16" soffit panels required, follow these simple steps:

1. Measure width of soffit from wall to outside of fascia board.
2. Measure length of overhang.
3. Use chart to find the number of panels needed.

LENGTH	WIDTH									
	12"	16"	20"	24"	28"	32"	36"	40"	44"	48"
8'	1	1	1	1	2	2	2	2	2	2
12'	1	1	2	2	2	3	3	3	3	3
16'	1	2	2	2	3	3	3	4	4	4
20'	2	2	3	3	3	4	4	5	5	5
24'	2	2	3	3	4	5	5	6	6	6
28'	2	3	3	4	5	6	6	7	7	7
32'	2	3	4	4	5	6	6	8	8	8
36'	3	3	4	5	6	7	7	9	9	9
40'	3	4	5	5	6	8	8	10	10	10
44'	3	4	5	6	7	9	9	11	11	11
48'	3	4	6	6	8	9	9	12	12	12
52'	4	5	6	7	8	10	10	13	13	13
56'	4	5	6	7	9	11	11	14	14	14
60'	4	5	7	8	9	12	12	15	15	15
64'	4	6	7	8	10	12	12	16	16	16
68'	5	6	8	9	11	13	13	17	17	17
72'	5	6	8	9	11	14	14	18	18	18
76'	5	7	9	10	12	15	15	19	19	19
80'	5	7	9	10	12	15	15	20	20	20
84"	6	7	9	11	13	16	16	21	21	21
88'	6	8	10	11	14	17	17	22	22	22
92'	6	8	10	12	14	18	18	23	23	23
96'	6	8	11	12	15	18	18	24	24	24
100'	7	9	11	13	15	19	19	25	25	25

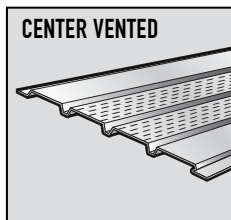
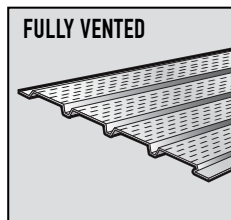
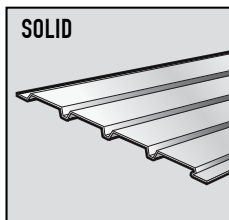

## Aluminum Soffit System Calculation Chart — 12"

To determine the number of 12" soffit panels required, follow these simple steps:

1. Measure width of soffit from wall to outside of fascia board.
2. Measure length of overhang.
3. Use chart to find the number of panels needed.

LENGTH	WIDTH									
	12"	16"	20"	24"	28"	32"	36"	40"	44"	48"
8'	1	1	2	2	2	2	2	3	3	3
12'	1	2	2	2	3	3	3	4	4	4
16'	2	2	3	3	4	4	4	6	6	6
20'	2	3	3	4	4	5	5	7	7	7
24'	2	3	4	4	5	6	6	8	8	8
28'	3	4	4	5	6	7	7	10	10	10
32'	3	4	5	6	7	8	8	11	11	11
36'	3	4	6	6	8	9	9	12	12	12
40'	4	5	6	7	8	10	10	14	14	14
44'	4	5	7	8	9	11	11	15	15	15
48'	4	6	7	8	10	12	12	16	16	16
52'	5	6	8	9	11	13	13	18	18	18
56'	5	7	8	10	12	14	14	19	19	19
60'	5	7	9	10	12	15	15	20	20	20
64'	6	8	10	11	13	16	16	22	22	22
68'	6	8	10	12	14	17	17	23	23	23
72'	6	8	11	12	15	18	18	24	24	24
76'	7	9	11	13	16	19	19	26	26	26
80'	7	9	12	14	16	20	20	27	27	27
84"	7	10	12	14	17	21	21	28	28	28
88'	8	10	13	15	18	22	22	30	30	30
92'	8	11	14	16	19	23	23	31	31	31
96'	8	11	14	16	20	24	24	32	32	32
100'	9	12	15	17	20	25	25	34	34	34

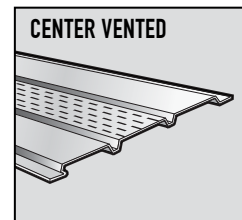
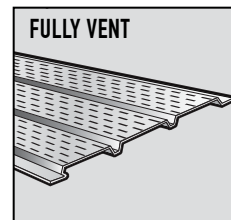
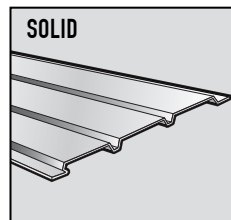





For more than 70 years ALSCO® has been driven to manufacture a diverse collection of products that stand out in the home building marketplace. Each has been carefully conceived, engineered and made to create maximum curb appeal to reflect a personality and taste for the look that is uniquely yours.

Since 1947 ALSCO® building products have played a leading role in introducing builders, re-modelers, and homeowners to the enduring beauty of low-maintenance aluminum building products. We customize and optimize every element of the manufacturing process to give you products that deliver unbeatable performance and value.



[www.alscometals.com](http://www.alscometals.com) • 800.521.2930

ALSCO METALS, 800 Chase Avenue, Elk Grove Village, IL 60007

Part #5SFTINST