



**DEPARTMENT OF REGULATORY AND ECONOMIC RESOURCES (RER)  
BOARD AND CODE ADMINISTRATION DIVISION  
NOTICE OF ACCEPTANCE (NOA)**

**MIAMI-DADE COUNTY  
PRODUCT CONTROL SECTION**  
11805 SW 26 Street, Room 208  
Miami, Florida 33175-2474  
T (786) 315-2590 F (786) 315-2599  
[www.miamidade.gov/economy](http://www.miamidade.gov/economy)

**Master Builders Solutions US, LLC  
23700 Chagrin Blvd.  
Beachwood, OH 44122**

**SCOPE:**

This NOA is being issued under the applicable rules and regulations governing the use of construction materials. The documentation submitted has been reviewed and accepted by Miami-Dade County RER-Product Control Section to be used in Miami-Dade County and other areas where allowed by the Authority Having Jurisdiction (AHJ). This NOA shall not be valid after the expiration date stated below. The Miami-Dade County Product Control Section (In Miami-Dade County) and/or the AHJ (in areas other than Miami-Dade County) reserve the right to have this product or material tested for quality assurance purposes. If this product or material fails to perform in the accepted manner, the manufacturer will incur the expense of such testing and the AHJ may immediately revoke, modify, or suspend the use of such product or material within their jurisdiction. RER reserves the right to revoke this acceptance if it is determined by Miami-Dade County Product Control Section that this product or material fails to meet the requirements of the applicable building code. This product is approved as described herein and has been designed to comply with the Florida Building Code, including the High Velocity Hurricane Zone.

**DESCRIPTION:**

**Senergy Senerflex Channeled Adhesive CI Design EIFS over 5/8” DensGlass Sheathing – S.M.I.**

**APPROVAL DOCUMENT:** Drawing titled “Senergy Assembly Detail for Senerflex Channeled Adhesive CI Design Wall System with Senershield-R over 5/8” DensGlass Sheathing and 16ga. Steel Frame (Small Missile)”, sheets 1 through 3 of 3, dated 01/17/2020, prepared by Master Builders Solutions US, LLC, signed and sealed by William O. Bishop, P.E. on 04/07/2020, bearing the Miami-Dade County Product Control approval stamp with the Notice of Acceptance number and expiration date by the Miami-Dade County Product Control Section.

**MISSILE IMPACT RATING: Small Missile Impact Resistant**

**LABELING:** Each unit shall bear a permanent label with the manufacturer's name or logo, Acworth, GA, model/series, and following statement: "Miami-Dade County Product Control Approved", unless otherwise noted herein. Components of this product come in different size buckets or drums. Each container needs to be labeled. Unit is further defined as each individual board of insulation and roll of reinforcing mesh.

**RENEWAL** of this NOA shall be considered after a renewal application has been filed and there has been no change in the applicable building code negatively affecting the performance of this product.

**TERMINATION** of this NOA will occur after the expiration date or if there has been a revision or change in the materials, use, and/or manufacture of the product or process. Misuse of this NOA as an endorsement of any product, for sales, advertising or any other purposes shall automatically terminate this NOA. Failure to comply with any section of this NOA shall be cause for termination and removal of NOA.

**ADVERTISEMENT:** The NOA number preceded by the words Miami-Dade County, Florida, and followed by the expiration date may be displayed in advertising literature. If any portion of the NOA is displayed, then it shall be done in its entirety.

**INSPECTION:** A copy of this entire NOA shall be provided to the user by the manufacturer or its distributors and shall be available for inspection at the job site at the request of the Building Official. This NOA consists of this page 1 and evidence page E-1, as well as approval document mentioned above. The submitted documentation was reviewed by **Carlos M. Utrera, P.E.**



**NOA No. 20-0630.07  
Expiration Date: October 15, 2025  
Approval Date: October 15, 2020  
Page 1**

**NOTICE OF ACCEPTANCE: EVIDENCE SUBMITTED**

**A. DRAWINGS**

1. Drawing titled “Senergy Assembly Detail for Senerflex Channeled Adhesive CI Design Wall System with Senershield-R over 5/8” DensGlass Sheathing and 16ga. Steel Frame (Small Missile)”, sheets 1 through 3 of 3, dated 01/17/2020, prepared by Master Builders Solutions US, LLC, signed and sealed by William O. Bishop, P.E. on 04/07/2020.

**B. TESTS**

1. Test reports on
  - 1) Air Infiltration Test, per FBC, TAS 202-94
  - 2) Uniform Static Air Pressure Test, Loading per FBC TAS 202-94
  - 3) Water Resistance Test, per FBC, TAS 202-94
  - 4) Small Missile Impact Test per FBC, TAS 201-94
  - 5) Cyclic Wind Pressure Loading per FBC, TAS 203-94

along with marked-up drawings and installation diagram of Senergy Assembly Detail for Senerflex Channeled Adhesive CI Design Wall System with Senershield-R over 5/8” DensGlass Sheathing and 16ga. Steel Frame, prepared by Intertek, Test Report No. **J3675.04-450-18 R0**, dated 01/08/2020, signed and sealed by Vinu J. Abraham, P.E.

**C. CALCULATIONS**

1. None.

**D. QUALITY ASSURANCE**

1. Miami-Dade Department of Regulatory and Economic Resources (RER)

**E. MATERIAL CERTIFICATIONS**

1. None.

**F. STATEMENTS**

1. Statement letter of code conformance to the 6<sup>th</sup> edition (2017) FBC prepared by William O. Bishop, P.E., 09/04/2020, signed and sealed by William O. Bishop, P.E.
2. Statement letter of no financial interest prepared by William O. Bishop, P.E., 04/27/2020, signed and sealed by William O. Bishop, P.E.



---

**Carlos M. Utrera, P.E.**  
**Product Control Examiner**  
**NOA No. 20-0630.07**  
**Expiration Date: October 15, 2025**  
**Approval Date: October 15, 2020**

# SENERGY

DATE: 1/17/20 Page 1 of 3

Assembly Detail for Senerflex Channeled Adhesive CI Design Wall System with Senershield-R over DensGlass Sheathing and 16ga Steel Frame (Small Missile)

REVISIONS DATES

FLORIDA P.E.: William O. Bishop, P.E.  
REGISTRATION NO.: 63305

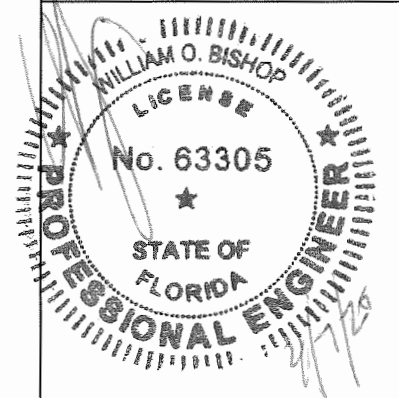

FOR OFFICE USE

**PRODUCT APPROVED**  
as complying with the Florida Building Code  
NOA-No. 20-0630.07  
Approval Date 10/15/2020  
By *[Signature]*  
Miami-Dade Product Control

Master Builders Solutions US, LLC  
23700 Chagrin Blvd  
Beachwood, OH 44122  
800-589-1336

## APPLICATION NOTES

- 1) SHEATHING FABRIC IS EMBEDDED IN SENERSHIELD-R AT SHEATHING JOINTS. SHEATHING FASTENERS ARE SPOTTED WITH SENERSHIELD-R.
- 2) APPLY SENERSHIELD-R TO SHEATHING SURFACE UNIFORMLY AT 10 MILS WET.
- 3) SENERGY BASE COAT IS MIXED AT THE TIME OF USE PER SENERGY INSTRUCTIONS WITH PADDLE AND DRILL TO A HOMOGENEOUS CONSISTENCY.
- 4) SENERGY BASE COAT IS APPLIED VERTICALLY TO THE BACK OF THE EPS INSULATION BOARD USING A 1/2" X 1/2" NOTCHED TROWEL HAVING 2" FLAT SEGMENTS BETWEEN NOTCHES.
- 5) MIAMI-DADE COUNTY APPROVED EPS INSULATION HAS A DENSITY OF 1 PCF AND IT SHALL BE APPLIED HORIZONTALLY IN A RUNNING BOND PATTERN STAGGERING VERTICAL JOINTS AND CORNERS.
- 6) AFTER BASE COAT IS DRIED AND INSULATION BOARD IS RASPED TO A SMOOTH SURFACE, A LAYER OF SENERGY BASE COAT IS APPLIED TO THE EXPOSED SURFACE. FLEXGUARD 4 REINFORCING MESH IS EMBEDDED IN THE WET BASE COAT BY TROWELING FROM THE CENTER OUT. ALL EDGES ARE LAPPED 2 1/2 INCHES.
- 7) SENERGY FINISH IS AN ACRYLIC BASED TEXTURED EXTERIOR COATING READY MIXED FROM THE FACTORY. IT IS APPLIED WITH A STAINLESS STEEL TROWEL AND FLOATED TO A DESIRED TEXTURE.

## GENERAL NOTES

- 1) THIS SYSTEM HAS BEEN DESIGNED IN ACCORDANCE WITH THE LATEST FLORIDA BUILDING CODE AND ITS LATEST SUPPLEMENTS.
- 2) THIS SYSTEM HAS BEEN TESTED IN ACCORDANCE WITH MIAMI-DADE COUNTY PROTOCOL TAS-201, TAS-202 & TAS-203 FOR SMALL MISSILE IMPACT, STRUCTURAL AND CYCLIC TESTING.
- 3) THIS SYSTEM SHALL BE APPLIED BY A LICENSED PLASTERING CONTRACTOR FOLLOWING THIS NOTICE OF ACCEPTANCE, THE RECOMMENDATIONS OF SENERGY AND THE APPLICABLE SECTION OF THE FLORIDA BUILDING CODE.
- 4) THE ENGINEER AND/OR ARCHITECT OF RECORD FOR EACH PROJECT USING THIS SYSTEM SHALL SIZE ALL STUD FRAMING TO ENSURE CONFORMANCE WITH STUD DEFLECTION AND STRESS LIMITATIONS AS REQUIRED BY GOVERNING CODE AND THIS DOCUMENT.
- 5) ALL STUDS USED WITH THIS SYSTEM SHALL BE COMPLETELY SHEATHED AT THE INTERIOR FLANGE OR BRIDGED AT MAXIMUM EVERY 5 FT. OF STUD LENGTH OR AS SPECIFIED BY THE STUD MANUFACTURER.
- 6) ALL STEEL STUDS SHALL BE STRUCTURAL WITH 1 5/8" MIN FLANGE WIDTH AND HAVE A MINIMUM YIELD STRENGTH OF 33000 PSI
- 7) DETAILS ON SHEET 2 & 3 OF 3 ARE TYPICAL AND SHOW INTENT TO PREVENT WATER INFILTRATION INTO AND BEHIND THE SYSTEM. ALTERNATE DETAILS AND SPECIFIC CONDITIONS NOT COVERED BY THE TYPICAL DETAILS ARE THE RESPONSIBILITY OF THE LICENSED DESIGN PROFESSIONAL IN CONSULTATION WITH SENERGY.

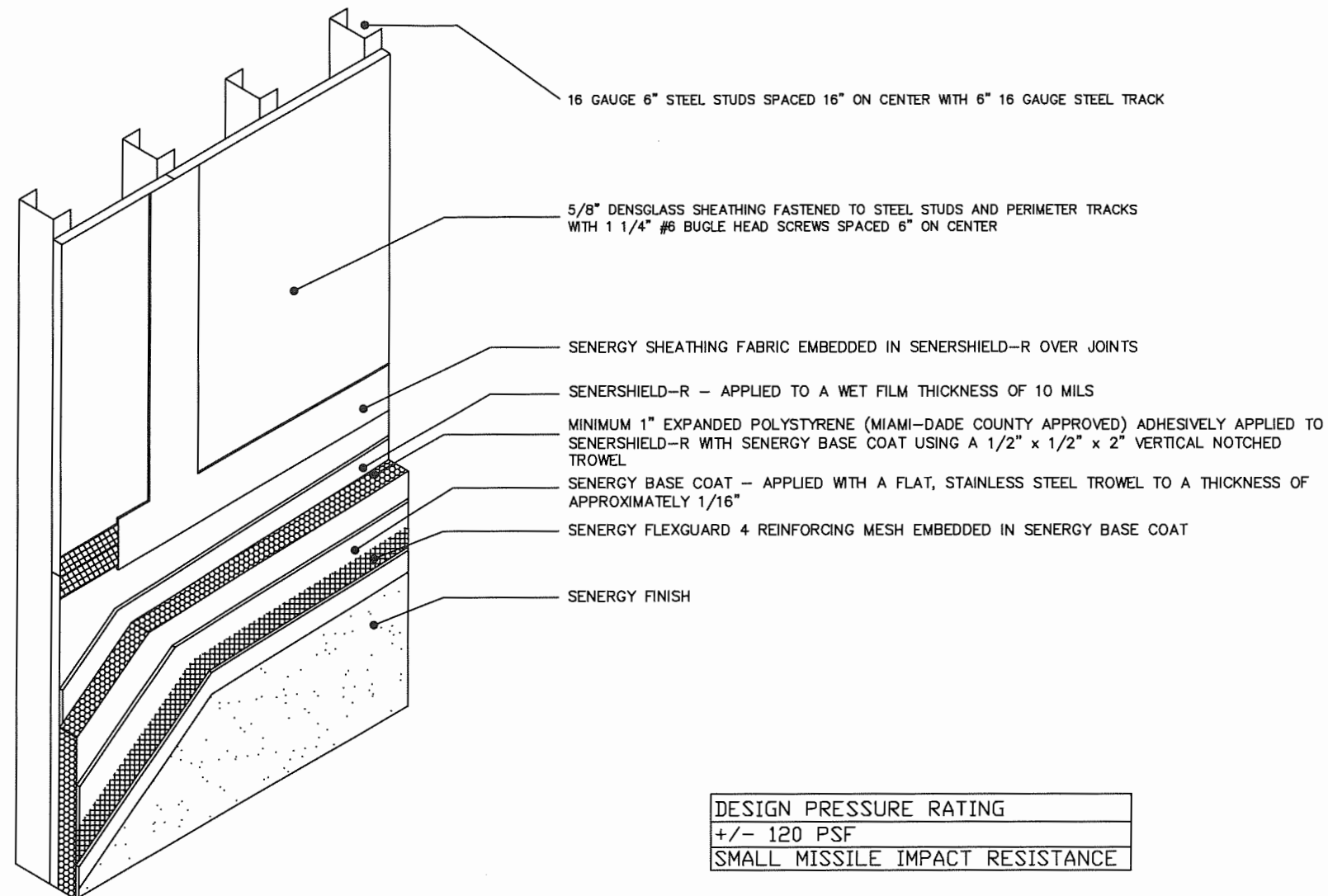

Typical Details for Senerflex  
Channeled Adhesive CI Design  
Wall System (Small Missile)

REVISIONS	DATES

FLORIDA P.E.: William O. Bishop, P.E.  
REGISTRATION NO.: 63305

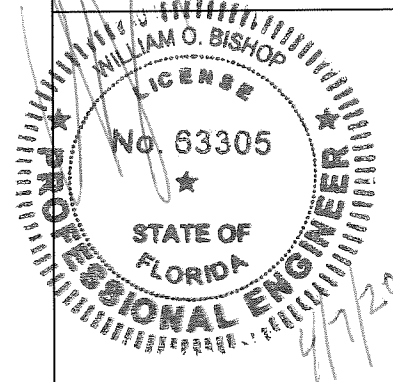

FOR OFFICE USE

**PRODUCT APPROVED**  
as complying with the Florida  
Building Code  
NOA-No. 20-0630.07  
Approval Date 10/15/2020  
By *[Signature]*  
Miami-Dade Product Control

Master Builders Solutions US, LLC  
23700 Chagrin Blvd  
Beachwood, OH 44122  
800-589-1336

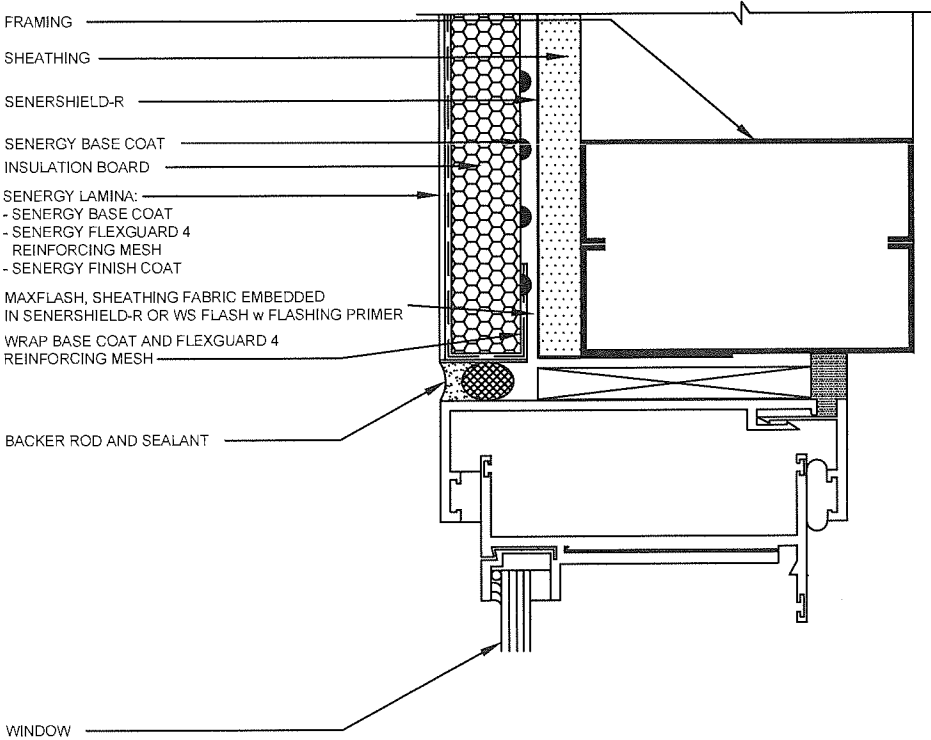

WINDOW JAMB DETAIL (FLUSH)

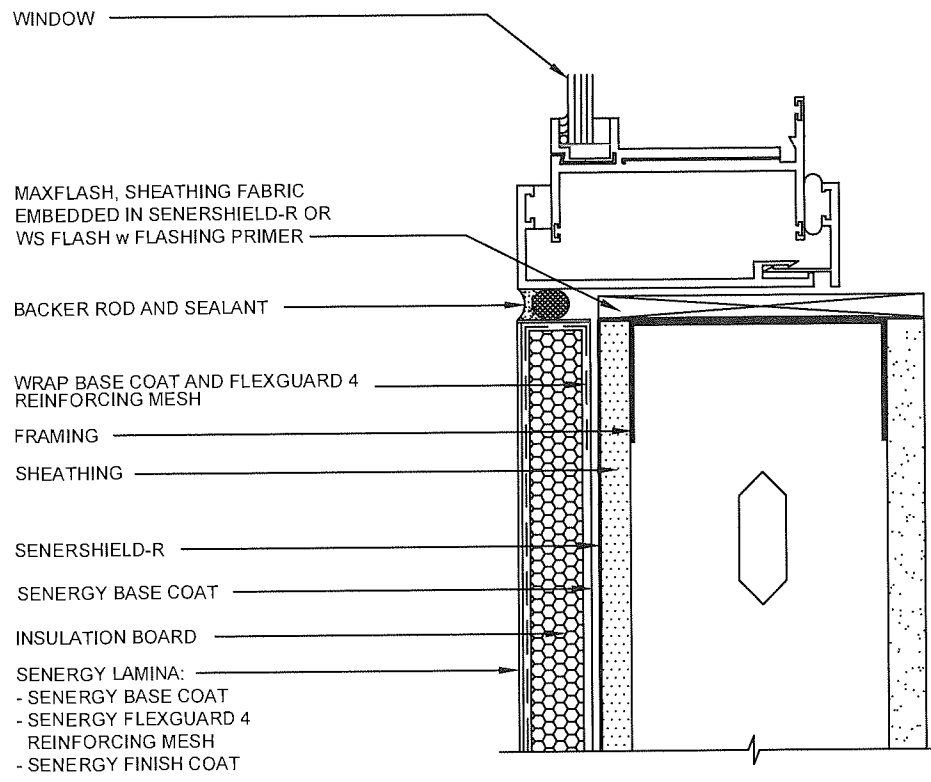

WINDOW SILL DETAIL (FLUSH)

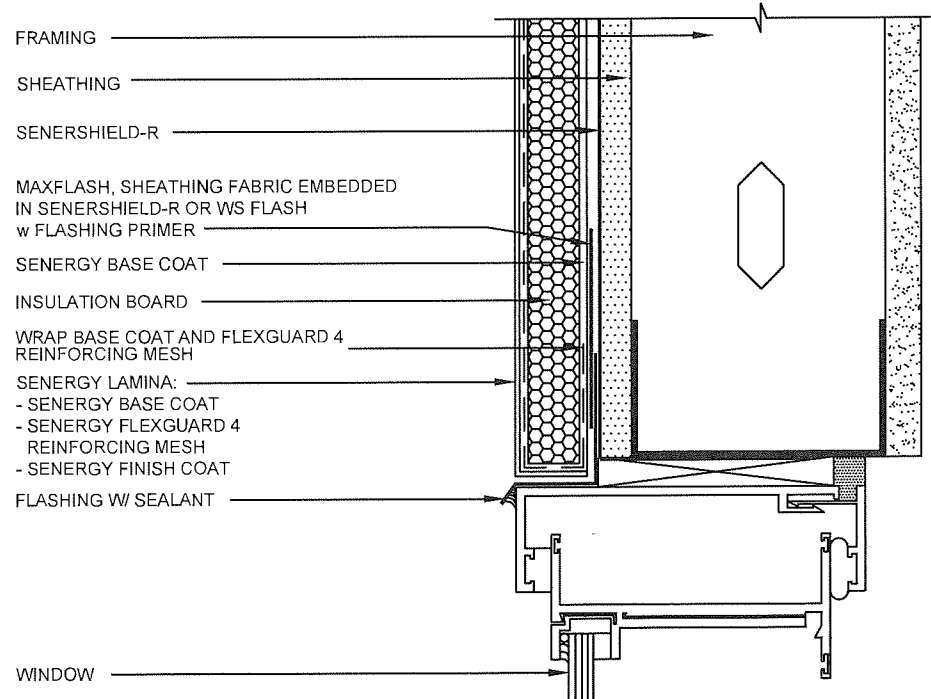

WINDOW HEAD (FLUSH)

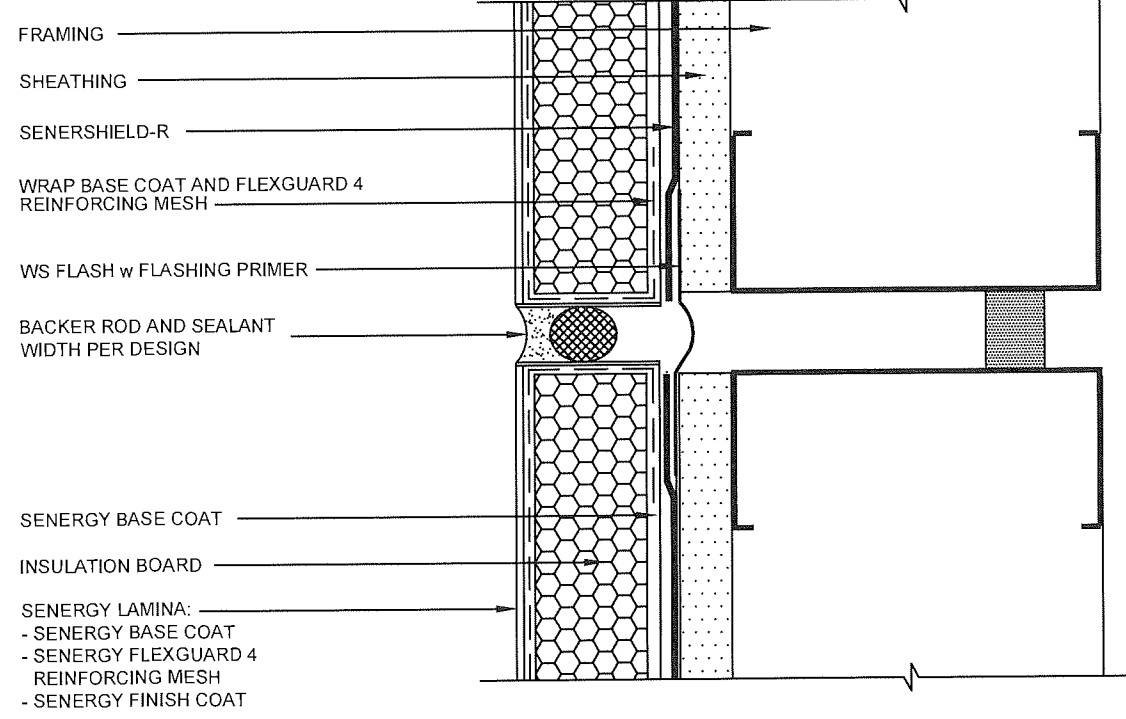

EXPANSION JOINT DETAIL (PLAN VIEW)



Typical Details for Senerflex  
Channeled Adhesive CI Design  
Wall System (Small Missile)

REVISIONS	DATES

FLORIDA P.E.: William O. Bishop, P.E.  
REGISTRATION NO.: 63305

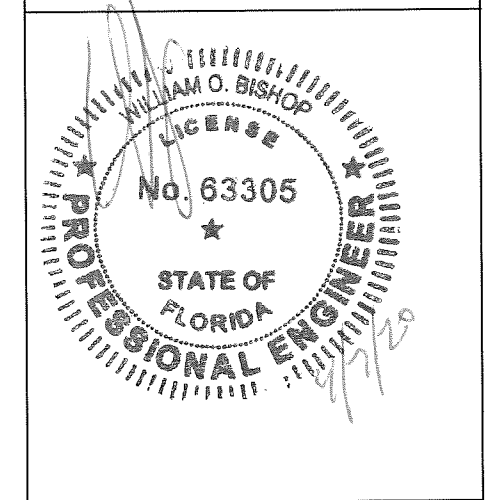

FOR OFFICE USE

**PRODUCT APPROVED**  
as complying with the Florida  
Building Code  
NOA-No. 20-0630.07

Approval Date 10/15/2020

By *[Signature]*  
Miami-Dade Product Control

Master Builders Solutions US, LLC  
23700 Chagrin Blvd  
Beachwood, OH 44122  
800-589-1336

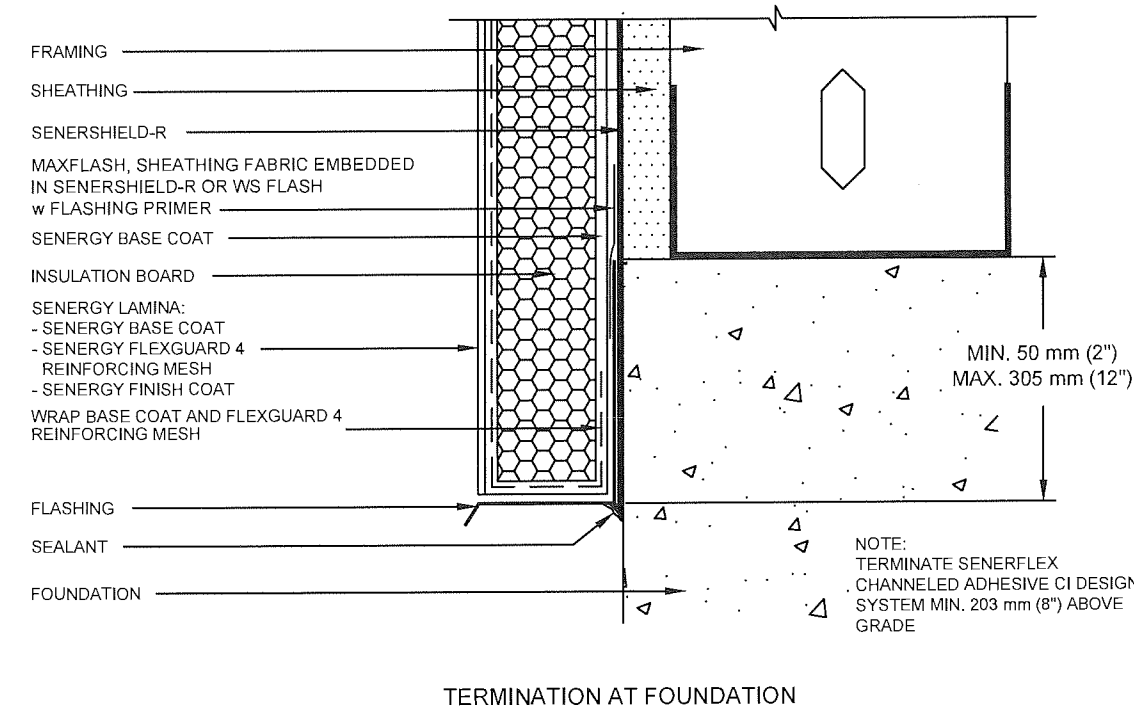
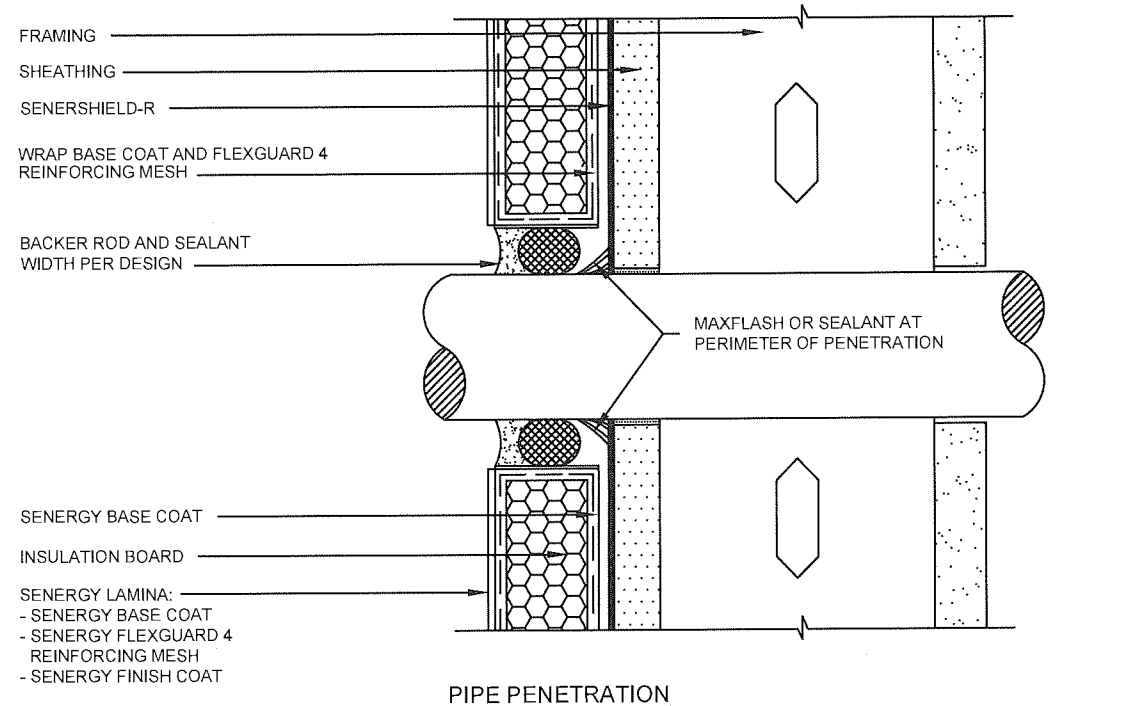

NOTE:  
TERMINATE SENERFLEX  
CHANNELED ADHESIVE CI DESIGN  
SYSTEM MIN. 203 mm (8") ABOVE  
GRADE

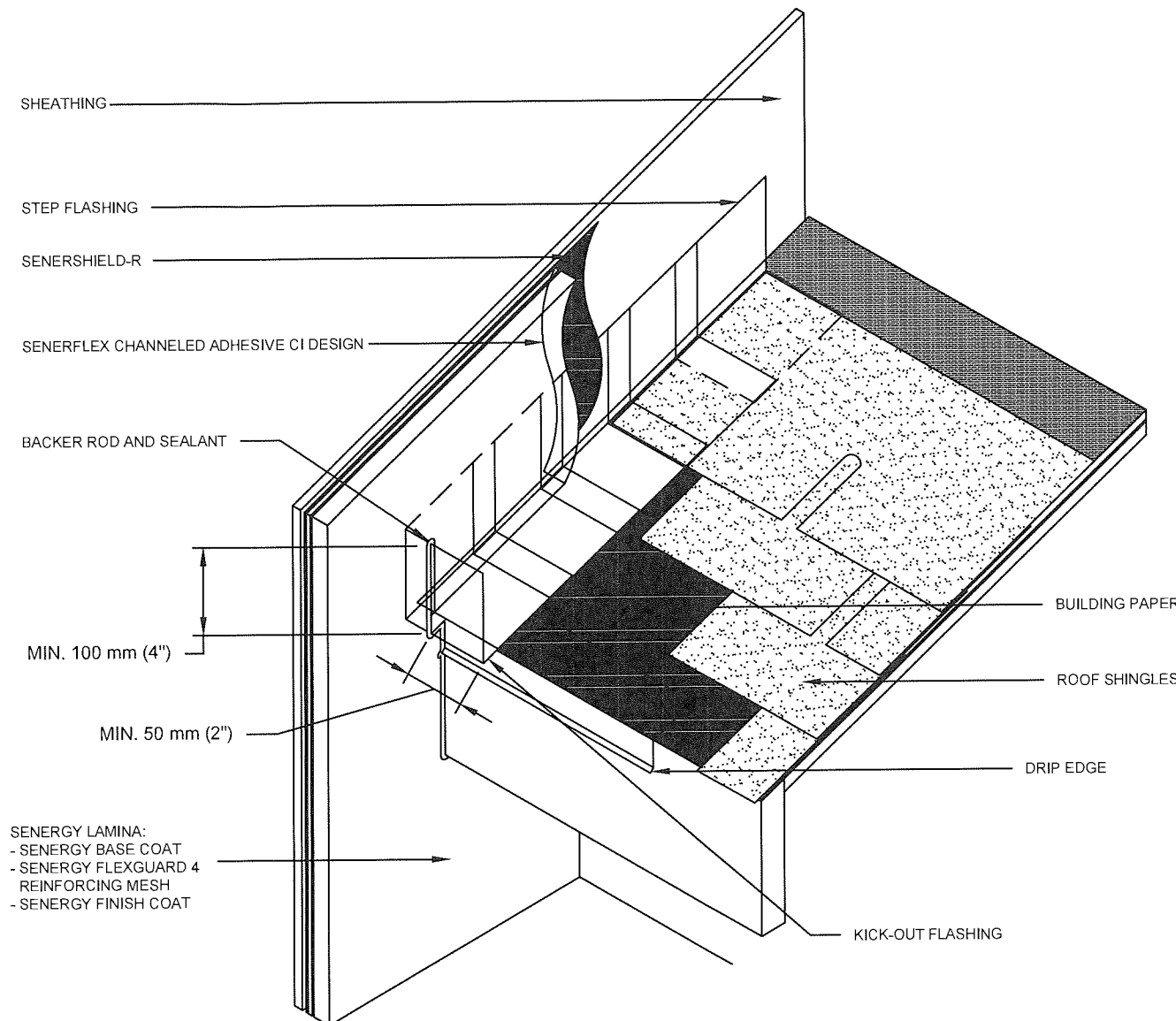

NOTE:  
- KICK-OUT FLASHING MUST BE ANGLED 100° MIN. TO ALLOW FOR PROPER DRAINAGE.  
- KICK-OUT FLASHING SEAMS MUST BE SOLDERED OR SEALED WITH APPROPRIATE SEALANT.  
- TERMINATE SENERFLEX CHANNELED ADHESIVE DESIGN MIN. 50 mm (2") ABOVE ROOF.  
- ROOFING DETAIL SHALL COMPLY WITH CHAPTER 15 OF THE F.B.C.